

# STOP GRUP<sup>®</sup>

**Safety** First



[www.stopgrup.com](http://www.stopgrup.com)



## Özel Askeri Kamp Projesi (Taşınabilir Askeri Kamp )

## Private Military Camp Project (Mobile Military Camp)

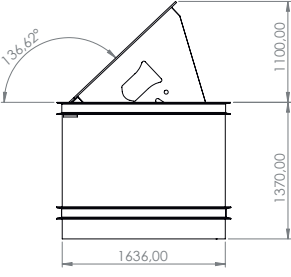

3D Video Link

**STOP GRUP®**[www.stopgrup.com](http://www.stopgrup.com)

Ürün QR Kodu



Product QR Code

## Anti Terör Yol Blok Bariyer

## Anti Terror Road Blocker

<b>Gövde Yapısı</b>	: St 37 Çelik
<b>Hareketli Parça</b>	: ST 44 Çelik (15mm)
<b>Çalışma Hızı</b>	: 0,20m/s
<b>Çalışma Voltajı</b>	: 380 V 50 - 60 Hz
<b>Çalışma Sıcaklığı</b>	: -25 + 60°C
<b>Motor Gücü</b>	: 3 - 4 - 5,5kW
<b>Çalışma Sıklığı</b>	: Günlük 500-3000 Tur
<b>Koruma Sınıfı</b>	: IP55
<b>Darbe Dayanımı</b>	: IWA14-1, PAS-68-ASTM2656, K12
<b>Yüzey Kaplama</b>	: Epoksi Boya

<b>Body Structure</b>	: St 37 Steel
<b>Moving Part</b>	: ST 44 Steel (15mm)
<b>Operating Speed</b>	: 0,20m/s
<b>Operating Voltage</b>	: 380 V 50 - 60 Hz
<b>Operational Temperature</b>	: -25 + 60°C
<b>Engine Power</b>	: 3 - 4 - 5,5kW
<b>Operating Frequency</b>	: Daily 500-3000 Cycles
<b>Ingress Protection</b>	: IP55
<b>Impact Resistance</b>	: IWA14-1, PAS-68-ASTM2656, K12
<b>Surface Coating</b>	: Epoxy paint

Makine ve Kimya Endüstrisi Kurumu  
Mechanical and Chemical Industry Company

Petkim Aliğa Rafinerisi  
Petkim Aliaga Refinery





[www.stopgrup.com](http://www.stopgrup.com)

**STOP BARIYER®**





1



2



3





4



5



6



**STOP**  
[www.stopgrup.com](http://www.stopgrup.com)

**Maximum Penetration  
(dynamic): -1.3m(P1)**

TEST VIDEO

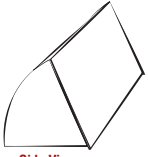
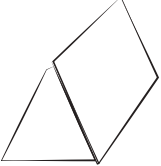

Side View  
Yan GörünüşSide View  
Yan Görünüş

Ürün QR Kodu



Product QR Code

## Yol Blok Bariyer

<b>Gövde Yapısı</b>	: St 37 Çelik
<b>Hareketli Parça</b>	: ST 37/44 Çelik (10/12mm)
<b>Çalışma Hızı</b>	: 0,20m/s
<b>Çalışma Voltajı</b>	: 380 V 50 - 60 Hz
<b>Çalışma Sıcaklığı</b>	: -25 + 60°C
<b>Motor Gücü</b>	: 1,5 - 2,2 - 3kW
<b>Çalışma Sıklığı</b>	: Günlük 500-3000 Tur
<b>Koruma Sınıfı</b>	: IP55
<b>Yüzey Kaplama</b>	: Epoksi Boya
<b>Trafik Işığı</b>	: Ø 100mm

## Road Blocker

<b>Body Structure</b>	: St 37 Steel
<b>Moving Part</b>	: ST 37/44 Steel (10/12mm)
<b>Operating Speed</b>	: 0,20m/s
<b>Operating Voltage</b>	: 380 V 50 - 60 Hz
<b>Operational Temperature</b>	: -25 + 60°C
<b>Engine Power</b>	: 1,5 - 2,2 - 3kW
<b>Operating Frequency</b>	: Daily 500 - 3000 Cycles
<b>Ingress Protection</b>	: IP55
<b>Surface Coating</b>	: Epoxy paint
<b>Traffic Light</b>	: Ø 100mm

Kosova NATO Üssü - Kosovo NATO Base



DHMI Türkiye Hava Trafik Kontrol Merkezi - DHMI Turkey Air Traffic Control Center







Ürün QR Kodu



Product QR Code

## Teleskopik Yol Blok Bariyer

## Telescopic Road Blocker (Shallow Mount Road Blocker)

<b>Gövde Yapısı</b>	: St 37 Çelik
<b>Hareketli Parça</b>	: ST 37/44 Çelik (10/12mm)
<b>Çalışma Hızı</b>	: 0,20m/s
<b>Çalışma Voltajı</b>	: 380 V 50 - 60 Hz
<b>Çalışma Sıcaklığı</b>	: -25 + 60°C
<b>Motor Gücü</b>	: 3 - 4 - 5,5kW
<b>Çalışma Sıklığı</b>	: Günlük 500-3000 Tur
<b>Koruma Sınıfı</b>	: IP55
<b>Yüzey Kaplama</b>	: Elektrostatik Boya
<b>Trafik Işığı</b>	: Ø 100mm

60cm nin üstünde kazı yapılamayacak yerlerde kullanılır

<b>Body Structure</b>	: St 37 Steel
<b>Moving Part</b>	: ST 37/44 Steel (10/12mm)
<b>Operating Speed</b>	: 0,20m/s
<b>Operating Voltage</b>	: 380 V 50 - 60 Hz
<b>Operational Temperature</b>	: -25 + 60°C
<b>Engine Power</b>	: 3 - 4 - 5.5 kW
<b>Operating Frequency</b>	: Daily 500 - 3000 Cycles
<b>Ingress Protection</b>	: IP55
<b>Surface Coating</b>	: Electrostatic paint
<b>Traffic Light</b>	: Ø 100mm

Used in places where no excavation can be performed on 60 centimetres

Deniz Harp Okulu - Turkish Naval Academy





Ürün QR Kodu



Product QR Code

## Zemin Üstü Yol Blok Bariyer

## On Ground Road Blocker

<b>Gövde Yapısı</b>	: St 37 Çelik
<b>Hareketli Parça</b>	: ST 44 Çelik (10/12mm)
<b>Çalışma Hızı</b>	: 0,20m/s
<b>Çalışma Voltajı</b>	: 380 V 50 - 60 Hz
<b>Çalışma Sıcaklığı</b>	: -25 + 60°C
<b>Motor Gücü</b>	: 3 - 4 - 5,5kW
<b>Çalışma Sıklığı</b>	: Günlük 500-3000 Tur
<b>Koruma Sınıfı</b>	: IP55
<b>Yüzey Kaplama</b>	: Elektrostatik Boya
<b>Trafik Işığı</b>	: Ø 100mm

<b>Body Structure</b>	: St 37 Steel
<b>Moving Part</b>	: ST 44 Steel (10/12mm)
<b>Operating Speed</b>	: 0,20m/s
<b>Operating Voltage</b>	: 380 V 50 - 60 Hz
<b>Operational Temperature</b>	: -25 + 60°C
<b>Engine Power</b>	: 3 - 4 - 5,5kW
<b>Operating Frequency</b>	: Daily 500-3000 Cycles
<b>Ingress Protection</b>	: IP55
<b>Surface Coating</b>	: Electrostatic paint
<b>Traffic Light</b>	: Ø 100mm





Ürün QR Kodu



Product QR Code

## Mobil Yol Blok Bariyer

## Mobile Road Blocker

<b>Gövde Yapısı</b>	: St 37 Çelik
<b>Hareketli Parça</b>	: ST 44 Çelik (10/12mm)
<b>Çalışma Hızı</b>	: 0,20m/s
<b>Çalışma Voltajı</b>	: 380 V 50 - 60 Hz
<b>Çalışma Sıcaklığı</b>	: -25 + 60°C
<b>Motor Gücü</b>	: 3 - 4 - 5,5kW
<b>Çalışma Sıklığı</b>	: Günlük 500-3000 Tur
<b>Koruma Sınıfı</b>	: IP55
<b>Yüzey Kaplama</b>	: Elektrostatik Boya
<b>Trafik Işığı</b>	: Ø 100mm

Taşınabilir, kurulup-kaldırılabilir.

<b>Body Structure</b>	: St 37 Steel
<b>Moving Part</b>	: ST 44 Steel (10/12mm)
<b>Operating Speed</b>	: 0,20m/s
<b>Operating Voltage</b>	: 380 V 50 - 60 Hz
<b>Operational Temperature</b>	: -25 + 60°C
<b>Engine Power</b>	: 3 - 4 - 5,5kW
<b>Operating Frequency</b>	: Daily 500-3000 Cycles
<b>Ingress Protection</b>	: IP55
<b>Surface Coating</b>	: Electrostatic paint
<b>Traffic Light</b>	: Ø 100mm

Portable, Mobile, Removable.



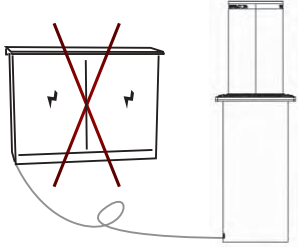

Led'li Alüminyum Kapak

Aluminum Cover With Led

Hareketli parça  
Ø273x8mm + 2mm  
CR304 paslanmaz çelik  
ve ana gövde çapı  
324 mm

Moving part is  
Ø273x8mm+2mm  
CR304 stainless steel  
and the main body's  
diameter is 324 mm

Hareket eden parça  
yüksekliği 600 mm

The height of the  
rising part is 600 mm



Ürün QR Kodu



Product QR Code

## Elektromekanik Mantar Bariyer (Ünitesi İçinde)

## Electromechanical Rising Bollard (Internal Unit)

<b>Çalışma Voltajı</b>	: 230 Vac 50 Hz
<b>Motor</b>	: D.C
<b>Akım</b>	: Min 8 A/ Max 18 A
<b>Maksimum başlangıç Torku</b>	: 63 N.m (1490 N – 152 kg)
<b>Nominal tork</b>	: 40 N.m (950 N – 97 kg)
<b>Motor frekansı</b>	: 36,66 Hz
<b>Motor açılma hızı</b>	: 230 1/s
<b>Redüksiyon oranı</b>	: 1/60
<b>Pinyon dişlisi</b>	: Z : 21 M:4 Db : 84 mm
<b>Koruma Sınıfı</b>	: IP68
<b>Nominal hız</b>	: 0,16 m/s
<b>Saatteki maksimum Tur</b>	: 360
<b>Çalışma süresi</b>	: 4-5min.
<b>Strok</b>	: 600-700mm
<b>Çalışma sıcaklıkları</b>	: -15 °C / + 50 °C
<b>Sınırlama switch tipi</b>	: Endüktif
<b>Elektrik kontrol ünitesi</b>	: PLC
<b>Güvenlik kiti</b>	: Loop dedektör veya fotosel.
<b>Mantar bariyer hareketli kısım</b>	: Ø273x8mm
<b>Dış koruyucu kasa</b>	: Ø324x5mm
<b>Cr 304 Paslanmaz Giydirme</b>	: Ø273x2mm
<b>Üst kapak</b>	: LED ışıklı şeritlerle Alüminyum kapak
<b>Gazlı amörtisör itme kuvveti</b>	: 400N

<b>Working Voltage</b>	: 230 Vac 50 Hz
<b>Engine</b>	: D.C
<b>Current</b>	: Min 8 A/ Max 18 A
<b>Maximum starting torque</b>	: 63 N.m (1490 N – 152 kg)
<b>Nominal torque</b>	: 40 N.m (950 N – 97 kg)
<b>Engine frequency</b>	: 36,66 Hz
<b>Motor angular velocity</b>	: 230 1/s
<b>Reduction ratio</b>	: 1/60
<b>Pinion Gear</b>	: Z : 21 M:4 Db : 84 mm
<b>Ingress Protection</b>	: IP68
<b>Nominal speed</b>	: 0,16 m/s
<b>Maximum turnover per hour</b>	: 360
<b>Total operation period</b>	: 4-5min.
<b>Stroke</b>	: 600-700mm
<b>Operational Temperature</b>	: -15 °C to + 50 °C
<b>Limiting switch type</b>	: Inductive
<b>Electric control unit</b>	: PLC
<b>Security kit</b>	: Loop detector or photocell.
<b>Rising bollard moving part</b>	: Ø273x8mm
<b>External protective casing</b>	: Ø324x5mm
<b>Cr 304 Stainless Covering</b>	: Ø273x2mm
<b>Top cover</b>	: Aluminum cover with LED light strips
<b>Gas damper thrust</b>	: 400N





## Hidrolik Mantar Bariyer (Hidrolik Ünitesi Dışında)

## Hydraulic Rising Bollards (External Hydraulic Unit)

<b>Çalışma Voltajı</b>	: 380 Vac 50 Hz
<b>Motor Gücü</b>	: 1,5 - 3 - 4 - 5kW
<b>İşlem Başına, dak/maks</b>	: 20/180
<b>Tahrik Sistemi</b>	: Hidrolik
<b>Kaldırma Pistonu</b>	: 40 x 600 x 25
<b>Hidrolik Hortum</b>	: R2 (Çift Helis) 400 Bar
<b>Dayanım Sürekliliği</b>	: %100
<b>Çalışma Ortam Sıcaklığı</b>	: -20 + 55
<b>Koruma Sınıfı</b>	: IP68
<b>Çalışma Hızı</b>	: 3/8" cm/s
<b>Güvenlik Sistemi</b>	: Loop Sensörü, Emniyet fotoseli, LED ışık
<b>Gövde</b>	: Ø323mm ST37 4 mm Derinlik
<b>Hareketli Bariyer Parçası</b>	: Ø273 St44 10mm Üst üst 2mm CR304 sta. çelik
<b>Yüzey Kaplama</b>	: Tüm yüzey sıcak daldırma galvaniz, 2mm CR304 paslanmaz çelik
<b>Montaj</b>	: Sertleştirilmiş taban çevresi dökme beton
<b>Kontroller</b>	: Mikroişlemci kartı, uzaktan kumanda

<b>Working Voltage</b>	: 380 Vac 50 Hz
<b>Engine Power</b>	: 1,5 - 3 - 4 - 5kW
<b>Per Operation, min/max</b>	: 20/180
<b>Drive System</b>	: Hydraulic
<b>Lifting Piston</b>	: 40 x 600 x 25
<b>Hydraulic Hose</b>	: R2 (Double Helix) 400 Bar
<b>Continuity of Durability</b>	: % 100
<b>Operating Temperature</b>	: -20 + 55
<b>Ingress Protection</b>	: IP68
<b>Operating Speed</b>	: 3/8" cm/s
<b>Safety System</b>	: Loop Sensor , Safety photocell , LED light
<b>Body</b>	: Ø323mm ST37 4 mm Steel
<b>Moving Barrier Part</b>	: Ø273 St44 10mm Steel top 2mm CR304 sta. steel
<b>Surface Coating</b>	: All surfaces are hot-dipped galvanized, with 2mm CR304 stainless steel
<b>Assembly</b>	: Cast concrete surrounding hardened base
<b>Controls</b>	: Micro-processor card, remote control





Anahtarla aktive edildiğinde gaz pistonuyla bariyeri yükseltir. Kapatmak için manüel olarak indirilir.

Bariyer kısmı 170mm Çap ve 3 mm kalınlık CR304 paslanmaz çelik. Reflektif bant veya kırmızı LED ışıklı güvenlik bariyeri

Kare bariyer kasası 160mm alüminyum dökümden yapılmıştır

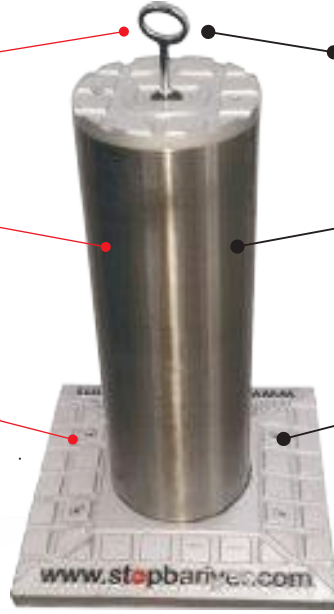

When activated with a key, the barrier rises by gas piston included within the system. Barrier is manually reduced for close

Bollard part consists of 170mm diameter and 3 mm thickness CR304 stainless steel. Reflective band or red Led light can be mounted as for safety on the bollard.

Flange and bollard covers are made of cast 160mm aluminium



Ürün QR Kodu



Product QR Code

## Manuel Mekanik Mantar Bariyer

## Manual Rising Bollard

- Tahrik Sistemi** : Manüel kontrollü gaz pistonu
- Kaldırma Pistonu** : 27x 500x10 (400N)
- Çalışma Sürekliliği** : 100%
- Çalışma Ortam Sıcaklığı** : -20 + 55
- Güvenlik Sınıfı** : IP68
- Hız** : 16cm / sn
- Manuel Sistem** : Kilit açıldığında, hareketli parça gazla yükseltilir Ayak ile basınç uygulayarak sistem kilitletir.
- Emniyet Sistemi** : Paslanmaz çelik üzeri reflektifli şerit
- Flanş ve Bariyer Örtüsü**: Dökme 160 Alüminyum
- Gövde** : Ø219x4 mm yüzey sıcak daldırma galvanizli
- Hareketli Bariyer Parçası**: 750x170x3mm Cr304 paslanmaz
- Yüzey Kaplama** : Gövde sıcak daldırma galvanizli, hareketli parça CR304 paslanmaz çelik
- Montaj** : Sertleştirilmiş taban çevresi dökme beton
- Kontrol** : Kilitli anahtar

- Drive System** : Manually controlled gas piston
- Lifting Piston** : 27x 500x10(400N)
- Continuity of Working**: 100%
- Operating Temperature** : -20 + 55
- Ingress Protection** : IP68
- Speed** : 16cm/sec
- Manual System** : When the lock opened, moving part is raised with gas pressure The system is locked back by applying pressure with the foot.
- Safety System** : Reflective band over stainless steel
- Flange and Barrier Cover** : Cast 160 Aluminium
- Body** : Ø219x4mm with surface hot dip galvanized
- Moving Part** : 750x170x3mm Cr304 stainless steel
- Surface Coating** : Body is hot dipped galvanized, moving part CR304 sta. steel
- Assembly** : Cast concrete surrounding hardened base
- Controls** : Keylock



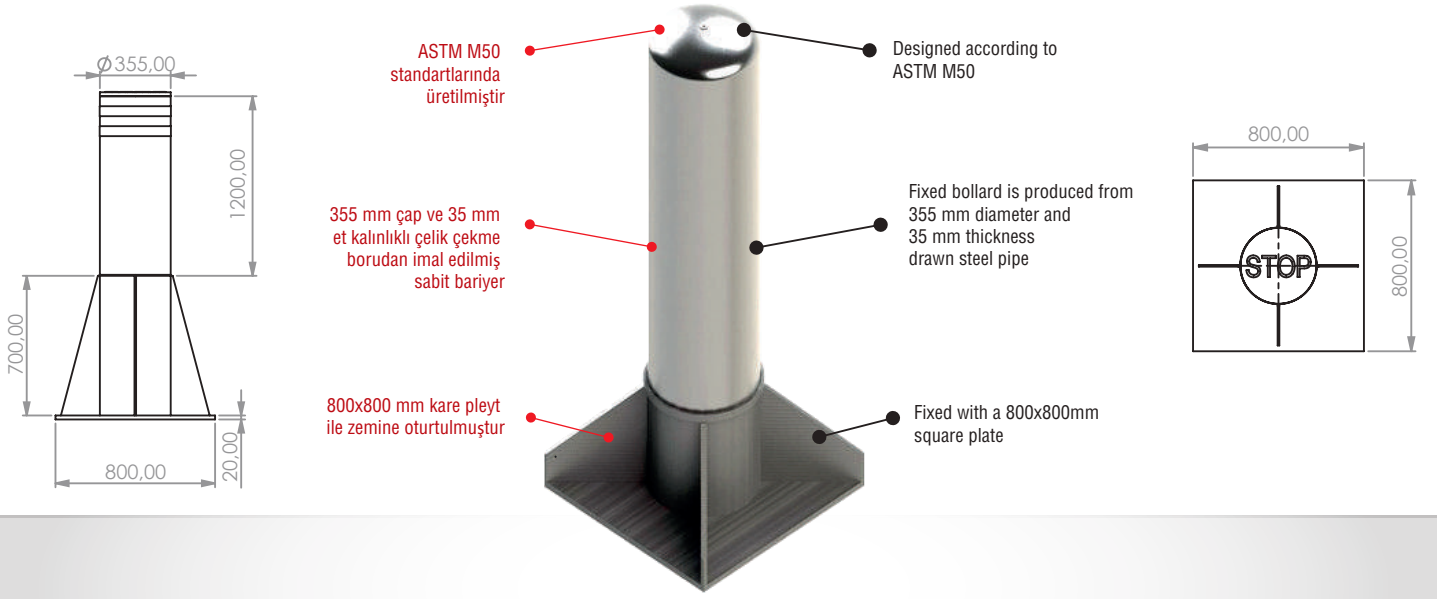

## Anti Terör Sabit Bariyer

- Çap** : Ø 355 mm  
**Bariyer Uzunluğu** : 1200 mm  
**Flanş Derinliği** : 700 mm  
**Pleyt** : 800x800x20 mm  
**Yüzey Kaplama** : Sıcak daldırma galvaniz ve elektrostatik toz boya  
**Montaj** : Sertleştirilmiş taban çevresi dökme beton

## Anti Terror Fixed Bollard

- Diameter** : Ø 355 mm  
**Barrier Height** : 1200 mm  
**Flange Deepness** : 700 mm  
**Plate** : 800x800x20 mm  
**Surface Coating** : Hot dipped galvanized and electrostatic powder coat  
**Assembly** : Cast concrete surrounding hardened base





Ürün QR Kodu



Product QR Code

## Yüksek Güvenlikli Kapı

- > 100 x 100 x 5 mm profil
- > 20'lik çelik halat
- > 22'lik çekme boru
- > 100'lük silindir rulman
- > Rulmanlı yataklama sistemi
- > Manuel veya uzaktan kumanda ile kontrol
- > İstenen ölçüde imalat
- > Motorlu sistem

## High Security Gate

- > 100 x 100 x 5 mm profile
- > 20" steel rope
- > 22" drawn pipe
- > 100" roller bearing
- > Roller bearing system
- > Manual or remote control
- > Can be manufactured in desired sizes
- > With Engine







Ürün QR Kodu



Product QR Code

## Yüksek Güvenlikli Kapı

- > 100 x 100 x 5 mm profil
- > 20'lik çelik halat
- > 22'lik çekme boru
- > 100'lük silindirik rulman
- > Rulmanlı yataklama sistemi
- > Manuel veya uzaktan kumanda ile kontrol
- > İstenen ölçüde imalat
- > Motorlu sistem

## High Security Gate

- > 100 x 100 x 5 mm profile
- > 20" steel rope
- > 22" drawn pipe
- > 100" roller bearing
- > Roller bearing system
- > Manual or remote control
- > Can be manufactured in desired sizes
- > With Engine





Ürün QR Kodu



Product QR Code

## Stop Kollu Bariyer

<b>Kol Kapasitesi</b>	: 3-4 Metre / 6 Metre
<b>Çalışma Gerilimi</b>	: 230
<b>Motor Gücü</b>	: 190
<b>Motor Tipi</b>	: 24 V Dc
<b>Açma Süresi</b>	: 2,5 - 5 sn
<b>Çalışma Sıklığı</b>	: Sürekli
<b>Koruma Sınıfı</b>	: IP55
<b>Çalışma Sıcaklığı</b>	: -10°/+50°

Uluslar arası standartlara uygun üretim.  
Ayarlanabilir fonksiyonlu bariyerler.  
Denge Yaylı sistemi ile motor yükü en aza indirilmiştir.  
Bariyer kolu her zaman kilitli durumdadır.  
Sıkışmaya karşı elektronik güvenlik önlemi.

## Stop Boom Bariyer

<b>Arm Capacity</b>	: 3-4 Meter / 6 Meter
<b>Working Voltage</b>	: 230
<b>Engine Power</b>	: 190
<b>Engine Type</b>	: 24 V Dc
<b>Opening Time</b>	: 2,5 - 5 sec
<b>Continuity of Working</b>	: Continually
<b>Ingress Protection</b>	: IP55
<b>Working Temperature</b>	: -10°/+50°

Production according to international standards.  
Functionally adjustable barriers.  
The engine load is reduced to the minimum  
with balance spring system.  
Barrier's arm is always locked.  
Electronic safety measure against jamming.





Ürün QR Kodu



Product QR Code

## Anti Terör Kollu Bariyer

## Anti Terror Arm Barrier

<b>Gövde Yapısı</b>	: 20 mm. ST44 çelik
<b>Açma/Kapama</b>	: Kumandalı Hidrolik Sistem (40sn.)
<b>Güvenlik Sınıfı</b>	: IP55
<b>Kol Ebatı</b>	: 350 x 175 x 2.000 - 10.000 mm.
<b>Kol Yüksekliği</b>	: 800 mm.
<b>Gövde Ebatı</b>	: 1500 x 1600 x 1100 mm.
<b>Uyarıcı</b>	: Kırmızı Led, Reflektif Şerit

<b>Body Structure</b>	: 20 mm. ST44 steel
<b>Opening Closing</b>	: Controlled hydraulic system (40sec.)
<b>Security Class</b>	: IP55
<b>Arm Size</b>	: 350 x 175 x 2.000 - 10.000 mm.
<b>Arm Height</b>	: 800 mm.
<b>Body Size</b>	: 1500 x 1600 x 1100 mm.
<b>Warning</b>	: Red Leds, Reflective strip

Uluslararası standartlara uygun üretim. Ayarlanabilir fonksiyonlu bariyerler. Bariyer kolu her zaman kilitli durumdadır. Sıkışmaya karşı elektronik güvenlik önlemi.

Production according to international standards. Functionally configurable barriers. The barriers are always locked. Electronic safety measure against jamming.



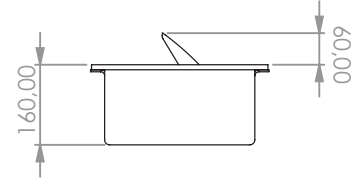
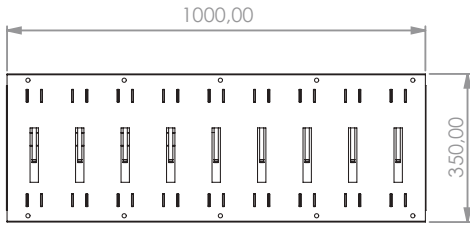

Ürün QR Kodu



Product QR Code

## Araç Zemin Altı Yer Tuzağı

<b>Gövde Yapısı</b>	: ST44 çelik
<b>Açma/Kapama</b>	: Manuel
<b>Güvenlik Sınıfı</b>	: Orta güvenlik
<b>Yüzey Kaplama</b>	: Epoksi boya
<b>Mızrak Kalınlığı</b>	: 10mm
<b>Mızrak Yüksekliği</b>	: 65mm

Özel tasarım mızraklı yol kapanı istenmeyen araçların girişini önlemek veya araç tekerleklerini engelleyen dişleriyle trafiği tek yönlü düzenlemek için kullanılır. Manuel olarak kilitlenebilen engellerdir.

## Underground Road Trap (Tire Killer)

<b>Body Structure</b>	: ST44 Steel
<b>Opening/Closing</b>	: Manuel lock
<b>Security Class</b>	: Medium security
<b>Surface Coating</b>	: Epoxy paint
<b>Spike Thickness</b>	: 10mm
<b>Spike Height</b>	: 65mm

Special designed tire killers are used to prevent unwanted cars passing or to regulate traffic in a certain direction. These traps are with manual locking system.

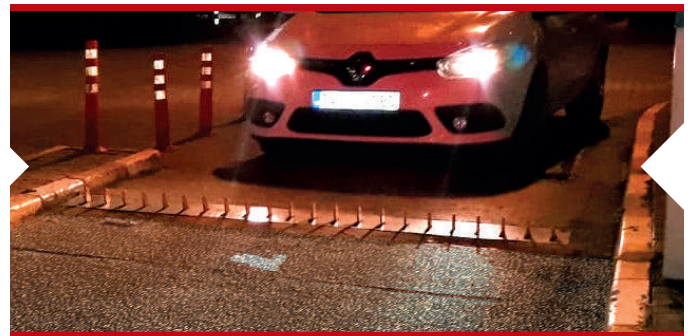
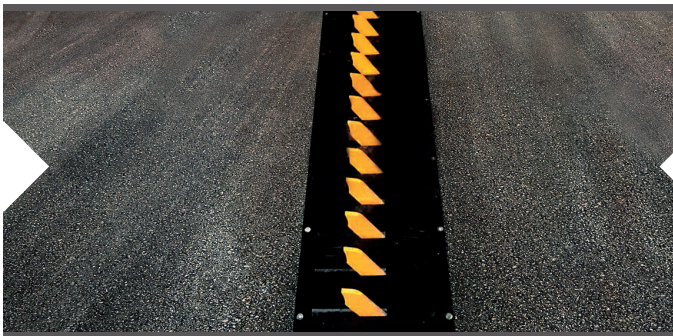

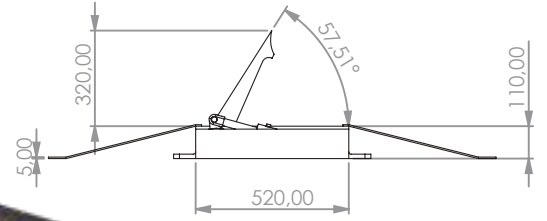

Ürün QR Kodu



Product QR Code

## Anti Terör Araç Zemin Üstü Tuzağı

## Anti Terror On Ground Road Trap (Tire Killer)

<b>Gövde Yapısı</b>	: 15mm ST44 çelik
<b>Açma/Kapama</b>	: Kumandalı Hidrolik Sistem (2sn.)
<b>Koruma Sınıfı</b>	: IP55
<b>Mızrak Kalınlığı</b>	: St 15mm Çelik
<b>Mızrak Yüksekliği</b>	: 320 mm.
<b>Opsiyonel</b>	: Kontrol Butonu
<b>Dış Kasa</b>	: 520(W) x 110(H) x 2000 / 5000(L)mm.

Özel tasarım mızraklı yol kapanı istenmeyen araçların girişini önlemek veya araç tekerleklerini engelleyen dişleriyle trafiği tek yönlü düzenlemek için kullanılır. Kumanda veya buton ile kontrol edilir.

<b>Body Structure</b>	: ST44 Steel
<b>Opening/Closing</b>	: Controlled hydraulic system (2sec.)
<b>Ingress Protection</b>	: IP55
<b>Spike Thickness</b>	: St 15mm Steel
<b>Spike Height</b>	: 320 mm.
<b>Optional</b>	: Control Button
<b>Outside Case</b>	: 520(W) x 110(H) x 2000 / 5000(L)mm.

Special designed tire killers are used to prevent unwanted cars passing or to regulate traffic in a certain direction. Controlled by remote control or buttons.



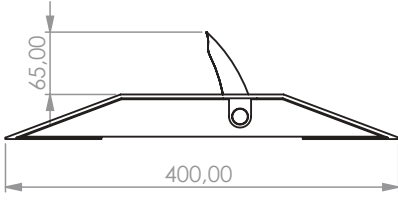

Ürün QR Kodu



Product QR Code

## Zemin Üstü Araç Yer Tuzağı

## On Ground Road Trap (Tire Killer)

<b>Gövde Yapısı</b>	: ST44 çelik
<b>Açma/Kapama</b>	: Manuel
<b>Güvenlik Sınıfı</b>	: Orta güvenlik
<b>Yüzey Kaplama</b>	: Epoksi boya
<b>Mızrak Kalınlığı</b>	: 10mm
<b>Mızrak Yüksekliği</b>	: 65mm
<b>Panel Boyutu</b>	: 1000mm

Özel tasarım mızraklı yol kapama istenmeyen araçların girişini önlemek veya araç tekerleklerini engelleyen dişleriyle trafiği tek yönlü düzenlemek için kullanılır. Manuel alyan kilitli çalışan engellerdir.

<b>Body Structure</b>	: ST44 Steel
<b>Opening/Closing</b>	: Manuel lock
<b>Security Class</b>	: Medium security
<b>Surface Coating</b>	: Epoxy paint
<b>Spike Thickness</b>	: 10mm
<b>Spike Height</b>	: 65mm
<b>Panel Size</b>	: 1000mm

Special designed tire killers are used to prevent unwanted cars passing or to regulate traffic in a certain direction. These tire killers are manual allen lock working traps.

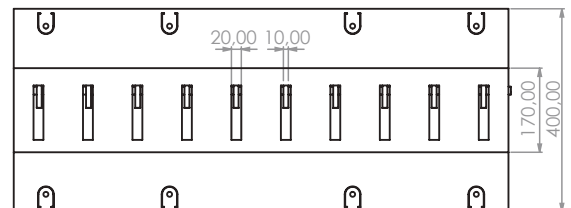
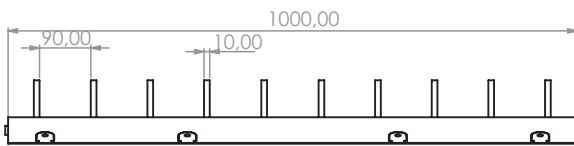

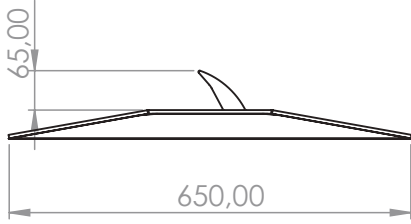

Ürün QR Kodu



Product QR Code

## Zemin Üstü Araç Yer Tuzağı

## On Ground Road Trap (Tire Killer)

<b>Gövde Yapısı</b>	: ST44 çelik
<b>Açma/Kapama</b>	: Manuel
<b>Güvenlik Sınıfı</b>	: Orta güvenlik
<b>Yüzey Kaplama</b>	: Epoksi boya
<b>Mızrak Kalınlığı</b>	: 10mm
<b>Mızrak Yüksekliği</b>	: 65mm
<b>Panel Boyutu</b>	: 1000mm

Özel tasarım mızraklı yol kapama istenmeyen araçların girişini önlemek veya araç tekerleklerini engelleyen dişleriyle trafiği tek yönlü düzenlemek için kullanılır. Manuel kilitle çalışan engellerdir.

<b>Body Structure</b>	: ST44 Steel
<b>Opening/Closing</b>	: Manuel lock
<b>Security Class</b>	: Medium security
<b>Surface Coating</b>	: Epoxy paint
<b>Spike Thickness</b>	: 10mm
<b>Spike Height</b>	: 65mm
<b>Panel Size</b>	: 1000mm

Special designed tire killers are used to prevent unwanted cars passing or to regulate traffic in a certain direction. These tire killers are manual lock working traps.

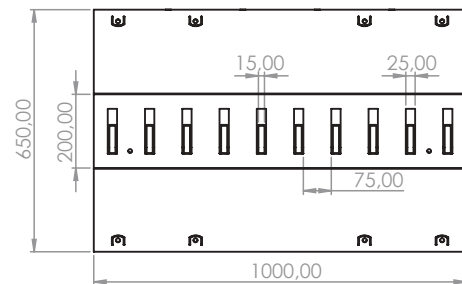
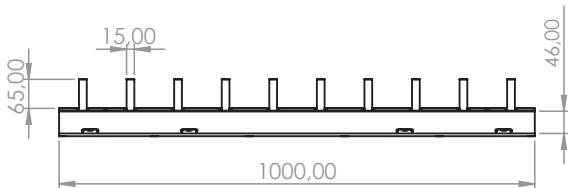



Ürün QR Kodu



Product QR Code

## Sabit Bariyerler ve Otopark Ürünleri

## Fixed Barrier And Parking Products

- ✓ Pratik Zincirli Bariyer
- ✓ Kilitli Otopark Direği
- ✓ Araç Stoperi
- ✓ Sabit Bariyerler

- ✓ Practical Chained Barrier
- ✓ Locked parking post
- ✓ Vehicle Stopper
- ✓ Fixed Barriers





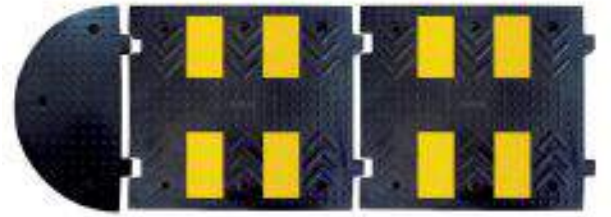

## Referanslar (Bazı Referanslarımız)



# References (Some of our references)



**STOP GRUP A.Ş.**

[www.stopgrup.com](http://www.stopgrup.com)

**STOP BARIYER**

[www.stopbariyer.com](http://www.stopbariyer.com)

**STOP ÇİT**

[www.stopcit.com](http://www.stopcit.com)

**STOP SPOR**

[www.stopspor.com](http://www.stopspor.com)

**STOP ENERJİ**

[www.stopenerji.com](http://www.stopenerji.com)

**STOP İNŞAAT**

[www.stopinsaat.com](http://www.stopinsaat.com)

**STOP TRAFİK**

[www.stoptrafik.com](http://www.stoptrafik.com)

**Stop Grup Güvenlik Sistemleri İnş. San. Tic. ve A.Ş.**

Güzelce Mahallesi İskenderun Caddesi No:6 E-5 Üzeri  
(Güzelce Kavşağı Yanı) Büyükçekmece - İstanbul / Türkiye

+90 212 868 08 90-91

+90 212 868 08 87

info@stopgrup.com



Address QR Code